



SURTEX
INSTRUMENTS

Crafted to Excellence



Tecnología e innovación veterinaria

www.unovet.es - info@unovet.es - Tel: 956 62 82 59



SURTEX
INSTRUMENTS

Crafted to Excellence

OUR PRODUCT BRANDS



A new dimension in cutting and dissecting performance. Our class leading integral self-sharpening technology standard on all Surtex scissors enabling precise cutting with minimum force even after pro-longed use.



These Surtex premium scissors feature finely ground micro serrations along one blade of the scissor preventing tissue slippage. The ultra sharp edge of the other blade cuts through the tissue precisely and atraumatically.



Instruments with this symbol benefit from tungsten carbide (TC) inserts expertly bonded on the cutting edge of the instrument. This material is harder than stainless steel and enables the instruments to last up to 6 times longer than standard instruments.



A true craftsmanship masterpiece and surgeons favourite. These are the best scissors in our range and combine the features of SuperEdge™ & UltraCut™ into a perfect pair of scissors that is precise, durable and reliable.



The only choice when the perfect grip matters. Utilising Creep Feed technology individual teeth are grinded into hard wear resistant tungsten carbide (TC). The result is super sharp teeth with well-defined point and inserts with impeccable gripping properties and instruments that last up to 6 times longer.



These instruments have jaws, which are coated with diamond dust resulting in improved gripping enabling superior manipulation of sutures, needles and tissues.



Our specially designed high strength fibre grip handles resulting in lightweight instruments. These ergonomic handles provide the surgeon with excellent feel, better grip, reduced shock, and less hand fatigue.



Surtex ENT diagnostic and anaesthesia instruments featuring direct bulb illumination of xenon grade bulbs.



This range features distal fibre optic to carry light from xenon bulb allowing cold illumination on operating site in our ENT diagnostics and anaesthesia instruments.



Premium grade ENT diagnostics and anaesthesia instruments combining features of distal fibre optic technology and ultra bright LED illumination ensuring the best in clear vision of operating site.



• PORTA AGUJAS

Mayo-Hegar Porta Agujas

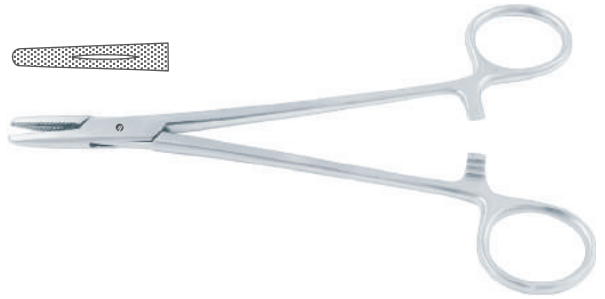

Catálogo #	Tamaño
SU-060-14	14.5 cm (5 3/4")

Mayo-Hegar Porta Agujas

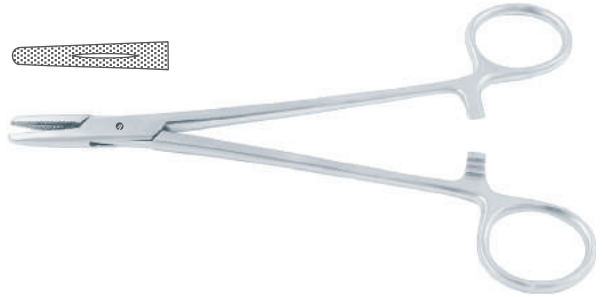

Catálogo #	Tamaño
SU-060-18	18.5 cm (7 1/4")

Mathieu Porta Agujas

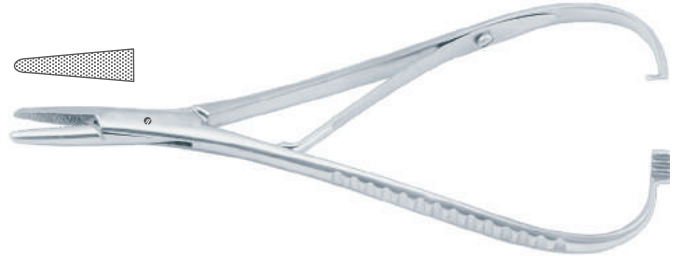

Catálogo #	Tamaño
SU-100-14	14 cm (5 1/2")

Mathieu Porta Agujas

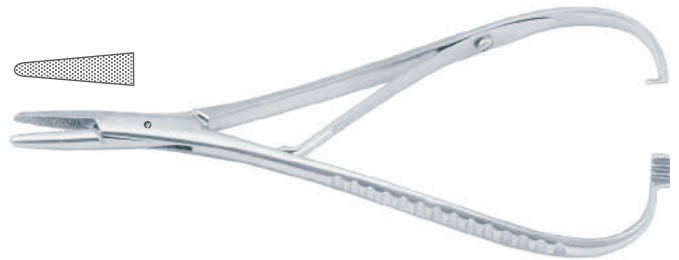

Catálogo #	Tamaño
SU-100-17	14 cm (5 1/2")

Gillies Porta agujas

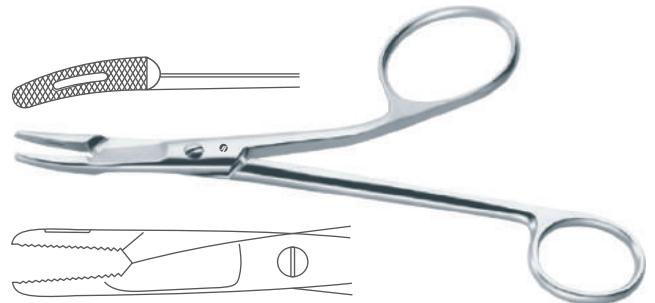

Catálogo #	Tamaño
SU-094-16	16 cm (6 1/4")



• PORTA AGUJAS

UltraGripX™ TC Mayo-Hegar Porta Agujas

ULTRA GRIPX

Catálogo #	Tamaño
SU-600-14	14.5 cm (5 ¾")

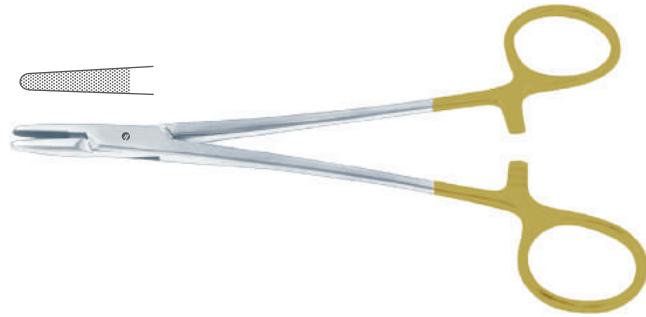

UltraGripX™ TC Mathieu Porta Agujas

ULTRA GRIPX

Catálogo #	Tamaño
SU-700-17	17 cm (6 ¾")



Olsen Hegar Porta Agujas

Catálogo #	Tamaño
SU-090-14	14 cm (5 ½")

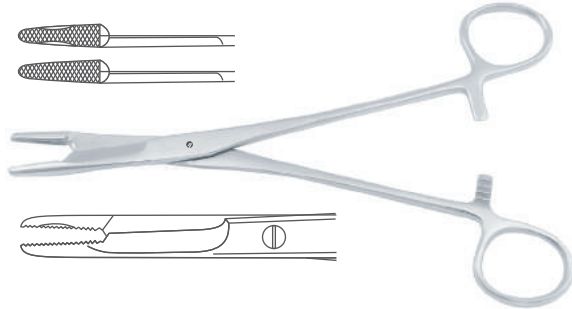

UltraGripX™ TC Olsen Hegar Porta Agujas

ULTRA GRIPX

Catálogo #	Tamaño
SU-690-14	14.5 cm (5 ¾")





• TIJERAS CIRUGÍA ESTÁNDAR

Tijeras de Cirugía
Recta, Romo/Romo



Catálogo #	Tamaño
SS-002-14	14.5 cm (5 3/4")

Tijeras de Cirugía
Curva, Romo/Romo

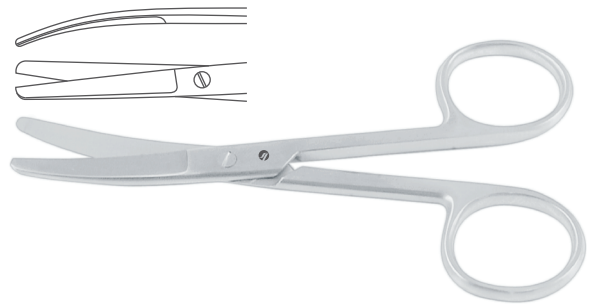

Catálogo #	Tamaño
SS-003-14	14.5 cm (5 3/4")

Tijeras de Cirugía
Recta, Aguda/Romo

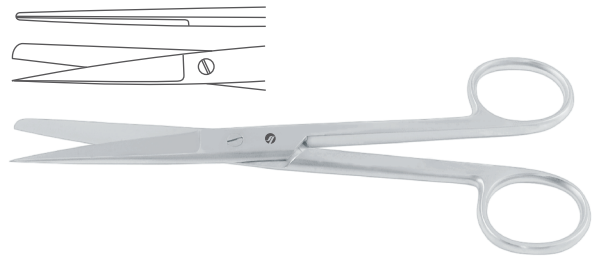

Catálogo #	Tamaño
SS-004-14	14.5 cm (5 3/4")

Wagner Tijeras de Cirugía
Recta



Catálogo #	Tamaño
SS-402-12	12 cm (4 3/4")

Delicada Tijeras de Cirugía
Recta

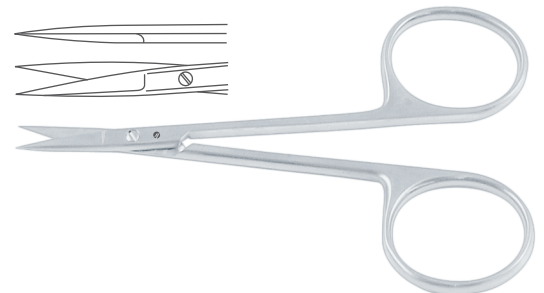

Catálogo #	Tamaño
SS-422-09	9 cm (3 1/2")



• TIJERAS DE DISECCIÓN

Mayo Tijeras de Disección
Recta

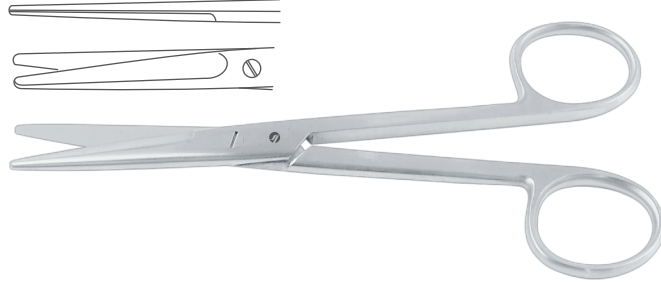

Catálogo #	Tamaño
SS-040-15	15 cm (6")

Mayo Tijeras de Disección
Curva

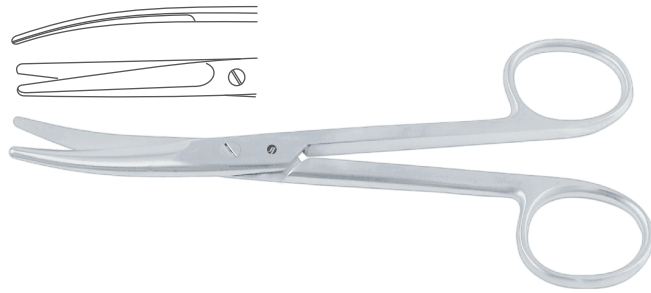

Catálogo #	Tamaño
SS-041-15	15 cm (6")

Metzenbaum Tijeras de Disección
Recta, Romo/Romo

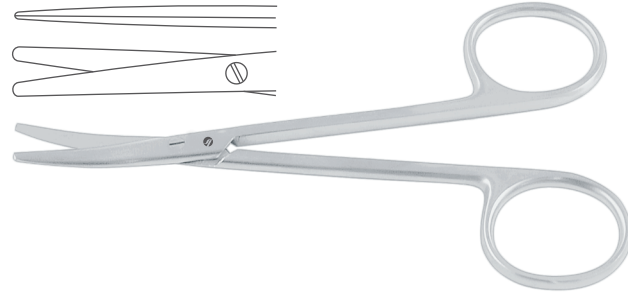

Catálogo #	Tamaño
SS-122-15	15.5 cm (6")

Metzenbaum Tijeras de Disección
Curva, Romo/Romo

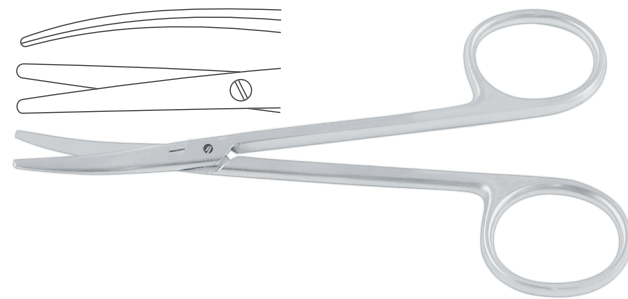

Catálogo #	Tamaño
SS-123-15	15.5 cm (6")

Metzenbaum Tijeras de Disección
Recta, Aguda/Aguda



Catálogo #	Tamaño
SS-134-14	14.5 cm (5 3/4")



• TIJERAS DE DISECCIÓN

Metzerbaum Tijeras de Disección
Curva, Aguda/Aguda



Catálogo #	Tamaño
SS-135-14	14.5 cm (5 3/4")

Metzerbaum-Nelson Tijeras de Disección
Recta, Romo/Romo

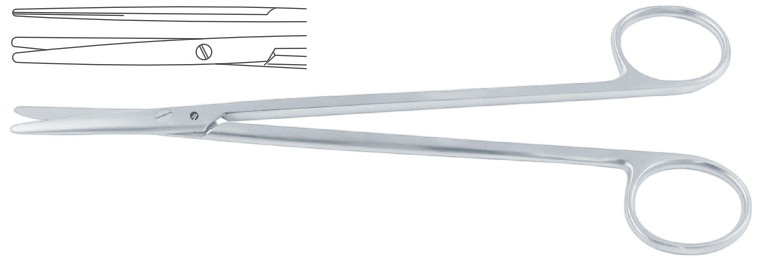

Catálogo #	Tamaño
SS-140-18	18 cm (7")

Kelly Tijeras de Disección
Recta

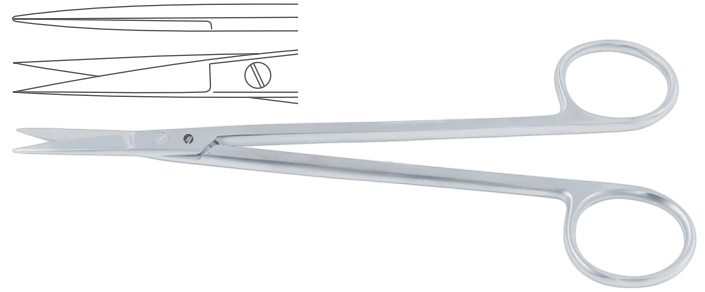

Catálogo #	Tamaño
SS-100-16	16 cm (6 1/4")

UltraGripX™ Metzenbaum Tijeras de Disección
Recta

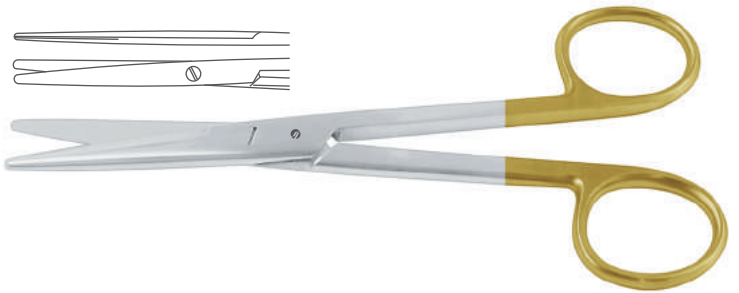

ULTRA *Cut*™

Catálogo #	Tamaño
SS-904-18	18 cm (7")



• TIJERAS PARA VENDAJES

Lister Tijeras de Venda

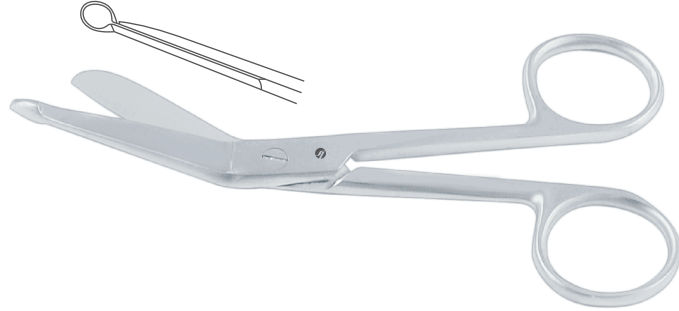

Catálogo #	Tamaño
SS-591-14	14.5 cm (5 ¾")
SS-591-18	18.5 cm (7 ¼")

Tijera Plastico Negro Venda



Catálogo #	Tamaño	Mango
SS-601-14	14.5 cm (5 ¾")	Black
SS-601-18	18 cm (7 ½")	Black



• TIJERAS PARA PUNTOS DE SUTURA

Littauer Tijeras de Stitch

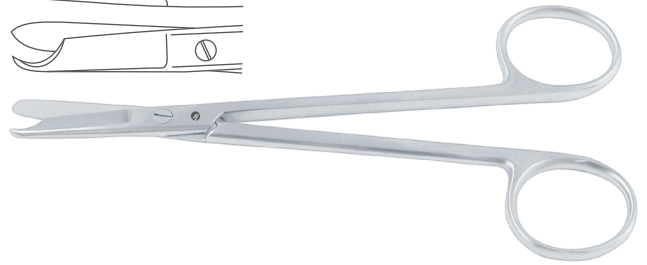
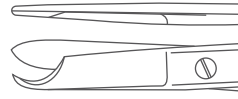

Catálogo #	Tamaño
SS-546-14	14 cm (5 1/2")

Littler Tijeras de Disección
Curva

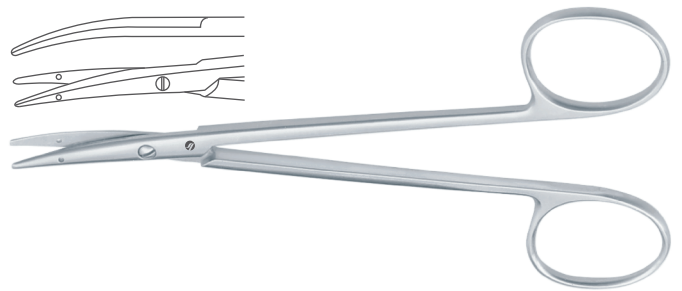
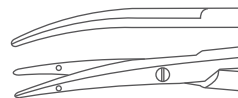

Catálogo #	Tamaño
SS-461-11	11.5 cm (4 1/2")

Northbent Tijeras de Stitch

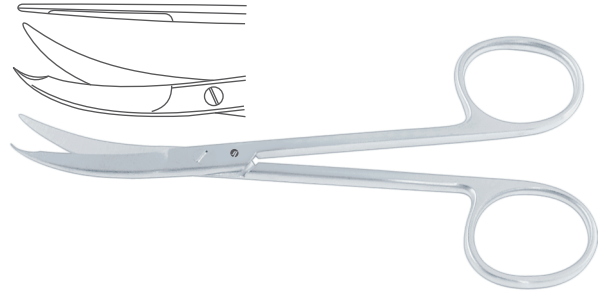
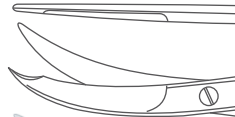

Catálogo #	Tamaño
SS-540-13	13 cm (5")



• TIJERAS FINAS

Stevens Tijeras de Tenotomía
Recta, Aguda/Aguda

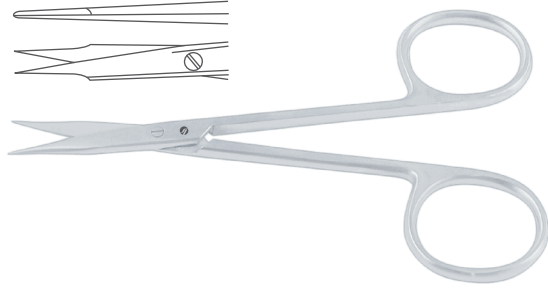

Catálogo #	Tamaño
SS-450-11	11 cm (4 ½")

Stevens Tijeras de Tenotomía
Curva, Romo/Romo

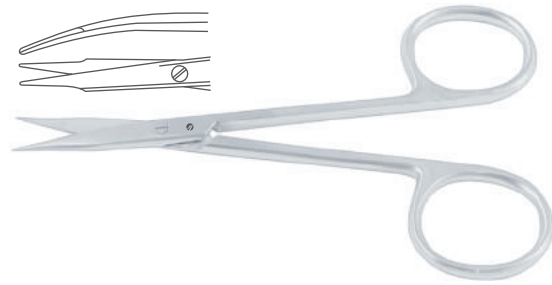

Catálogo #	Tamaño
SS-453-11	11 cm (4 ½")



• PINZAS DE DISECCIÓN

Feilchenfeld Pinza Para Espinas

Catálogo #	Tamaño
FR-610-09	9 cm (3 1/2")
FR-610-11	11.5 cm (4 1/2")



Standard Pinza De Disección Con Dientes Recta, 1 x 2 Dientes

Catálogo #	Tamaño
FR-200-13	13 cm (5")

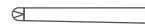

Standard Pinza De Disección Con Dientes Recta, 2 x 3 Dientes

Catálogo #	Tamaño
FR-202-13	13 cm (5")



Lane Pinza De Disección Con Dientes 2 x 3 Dientes

Catálogo #	Tamaño
FR-362-14	14.5 cm (5 3/4")

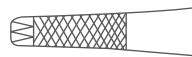



• PINZAS HEMOSTÁTICAS

Pean Pinza Hemostática

Catálogo #	Tamaño
AF-110-14	14.5 cm (5 ¾")

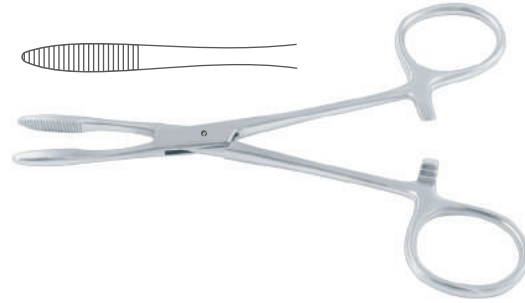

Hartmann Pinza Hemostática Recta

Catálogo #	Tamaño
AF-140-10	10 cm (4")



Hartmann Pinza Hemostática Curva

Catálogo #	Tamaño
AF-141-10	9.5 cm (3 ¾")



Martel-Rees Pinza Para Face-Lift

Catálogo #	Tamaño
AF-138-14	13.5 cm (5 ¼")

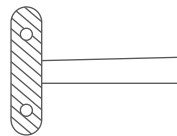

Halsted-Mosquito Pinza Hemostática Recta

Catálogo #	Tamaño
AF-160-12	12.5 cm (4 ¾")

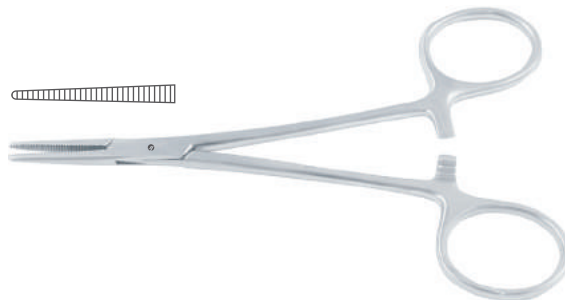



• PINZAS HEMOSTÁTICAS

Halsted-Mosquito Pinza Hemostática Curva

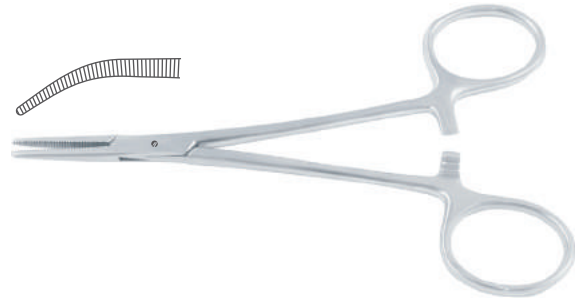

Catálogo #	Tamaño
AF-161-12	12 cm (4 3/4")

Micro-Mosquito Pinza Hemostática Recta



Catálogo #	Tamaño
AF-170-10	10 cm (4")

Micro-Mosquito Pinza Hemostática Curva



Catálogo #	Tamaño
AF-171-12	11.5 cm (4 1/2")

Halsted-Mosquito Pinza Hemostática Curva

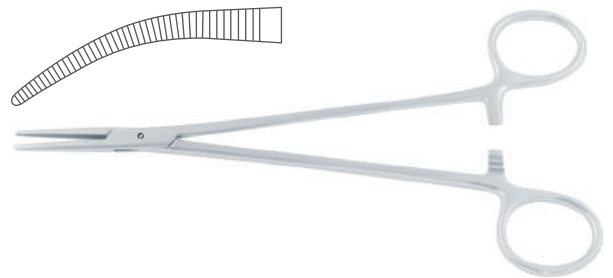

Catálogo #	Tamaño
AF-177-18	18 cm (7")

Kocher (Delicate) Pinza Hemostática Curva, 1 x 2 Dientes

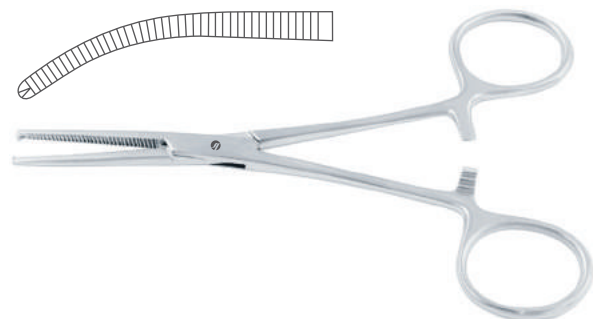

Catálogo #	Tamaño
AF-249-14	14 cm (5 1/2")



• PINZAS HEMOSTÁTICAS

Coller Pinza Hemostática
Recta

Catálogo #	Tamaño
AF-260-14	14 cm (5 ½")
AF-260-18	18.5 cm (7 ¼")

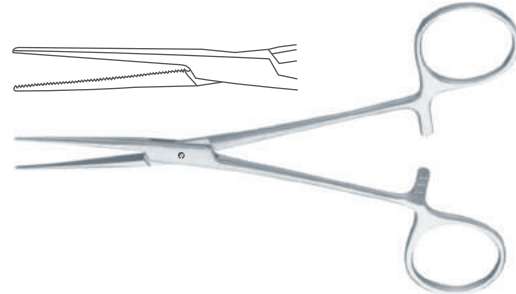

Coller Pinza Hemostática
Curva

Catálogo #	Tamaño
AF-261-16	16.5 cm (6 ½")

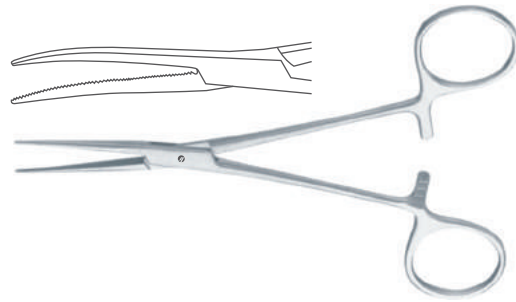

Kelly Pinza Hemostática
Recta

Catálogo #	Tamaño
AF-200-14	14.5 cm (5 ¾")

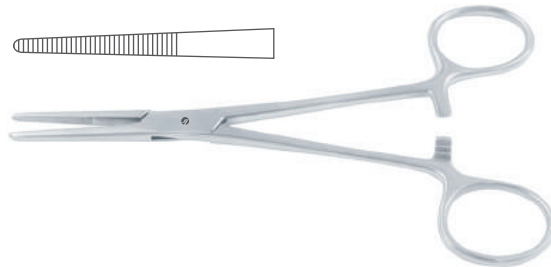

Kelly Pinza Hemostática
Curva

Catálogo #	Tamaño
AF-201-14	14 cm (5 ½")

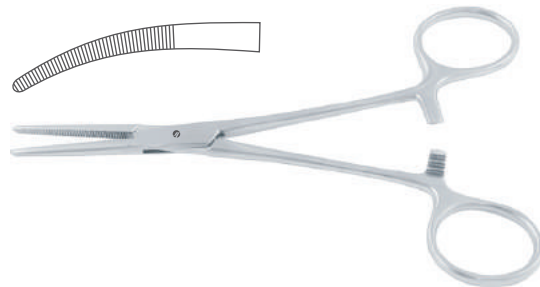



• ALLIS

Allis Pinza Para Coger Tejidos E Intestinos
4 x 5 Dientes

Catálogo #	Tamaño
SI-010-12	13 cm (5")

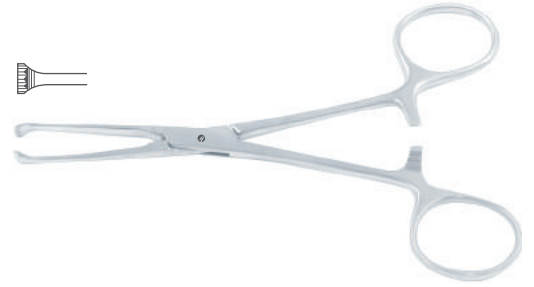

Allis Pinza Para Coger Tejidos E Intestinos
5 x 6 Dientes

Catálogo #	Tamaño
SI-015-15	15.5 cm (6")
SI-015-19	19 cm (7 ½")



• DOYEN

Doyen Pinza Clamp Intestinal
Recta

Catálogo #	Tamaño
SI-100-18	18 cm (7")

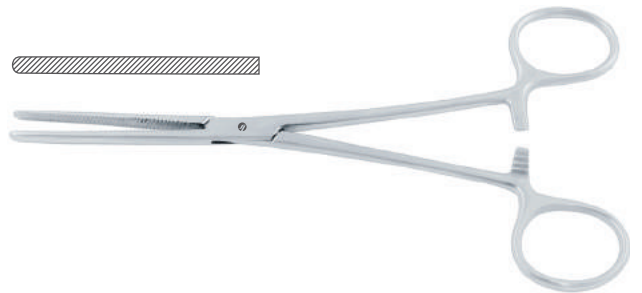

Doyen Pinza Clamp Intestinal
Recta

Catálogo #	Tamaño
SI-102-21	21.5 cm (8 ½")

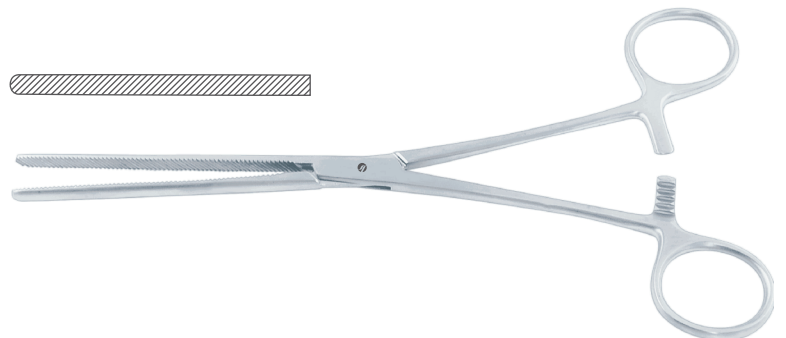



• TRAUMATOLOGÍA

Ruskin-Liston Pinza Cortante Para Huesos Recta



Catálogo #	Tamaño
OR-980-18	18 cm (7")

Micro Mini Pinza Cortante Para Pin y Ligadura
Ángulo 15° - Para pasadores de alambre blando y ligadura de hasta 0,30 mm

ULTRA Cut™



Catálogo #	Tamaño
DO-990-05	Standard

Ruskin-Liston Pinza Cortante Para Huesos Recta



Catálogo #	Tamaño
OR-972-14	14 cm (5 1/2")

Kern Pinza Para Huesos

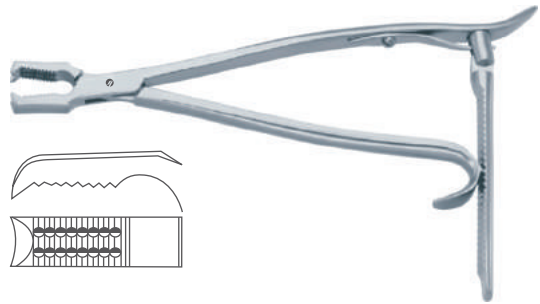

Catálogo #	Tamaño
OR-896-17	17 cm (6 3/4")

Lane Pinza Para Huesos
Con Trinquete



Catálogo #	Tamaño
OR-918-33	33 cm (13")

• **TRAUMATOLOGÍA**

Pinza Cortante Para Alambre
Para cables blandos de hasta 2,2 mm Ø, para cables rígidos de hasta 2,0 mm Ø

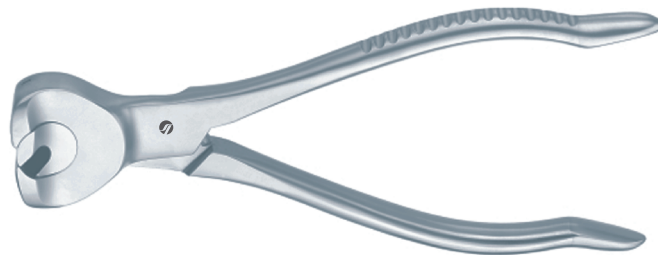

Catálogo #	Tamaño
OR-222-16	16 cm (6 1/4")

FomonNasal Escofina Doble

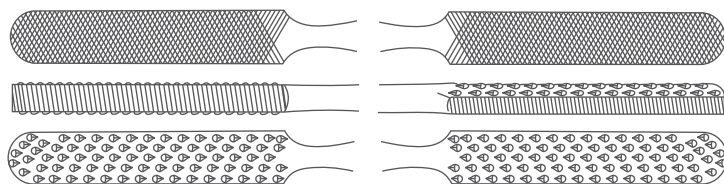

Catálogo #	Tamaño
RH-744-21	20.5 cm (8"), 30 x 8 mm



Gerzog Martillo de Hueso



Catálogo #	Tamaño, Diámetro del cabezal, Peso
OR-460-17	19 cm (7 1/2"), Ø 25.0 mm, 225 Grams

Volkman Matillo De Hueso
Oval



Catálogo #	Tamaño, Cucharilla Tamaño
OR-526-06	17 cm (6 3/4"), 5.2 mm, Fig. 6

Senn-Miller Ganchos
Cortante



Catálogo #	Tamaño, Tamaño de la hoja
RT-162-16	16 cm (6 1/4"), 20 x 7 mm



• TRAUMATOLOGÍA

Senn-Miller Ganchos
Romo



Catálogo # Tamaño, Tamaño de la hoja
RT-163-16 16 cm (6 1/4"), 20 x 7 mm

Weitlaner Separadores
3 x 4 Dientes Cortante

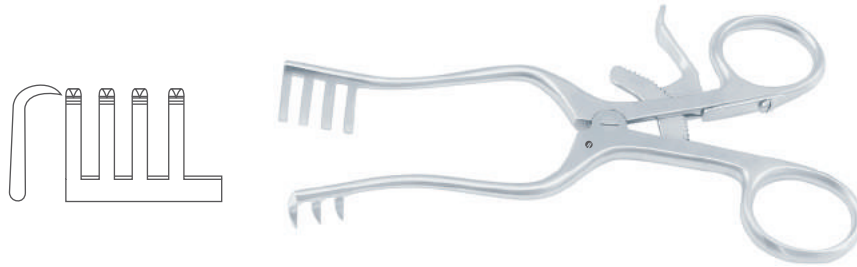

Catálogo # Tamaño
RT-712-16 16 cm (6 1/4")

UltraCut™ TC Tijeras Para Iris
Angulo

ULTRA *Cut*™

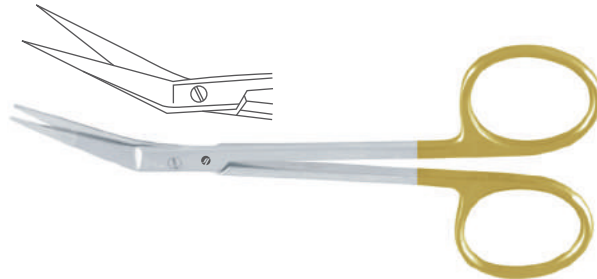

Catálogo # Tamaño
SS-985-11 11 cm (4 1/2")

Gigli Mango

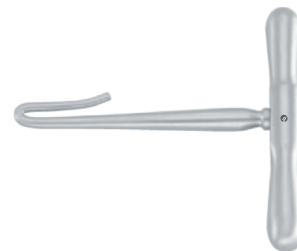

Catálogo # Tamaño
NS-055-00 Standard

Freer Elevador Para Nasal Tabique
Cortante/Romo



Catálogo # Tamaño, Tamaño de la hoja1, Tamaño de la hoja 2
RH-475-18 18.5 cm (7 1/4"), 5.0 mm, 5.0 mm



• TRAUMATOLOGÍA

Kocher Pinza Clamp Intestinal
Recta

Catálogo #	Tamaño
SI-122-22	22.5 cm (8 ¾")
SI-122-25	25 cm (9 ¾")

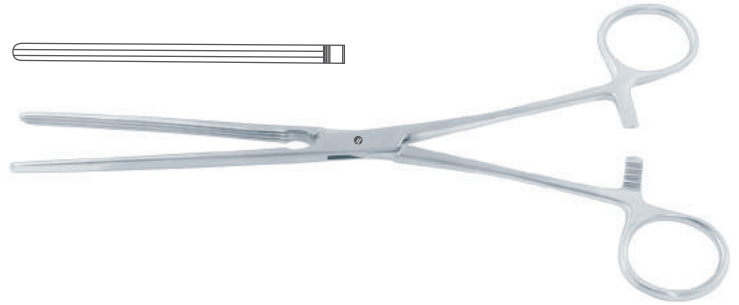



• MANGOS DE BISTURÍ

Mango de Bisturí # 3
Macizo



Catálogo #	Tamaño
SL-010-03	12 cm (4 ¾")

Mango de Bisturí # 4
Macizo



Catálogo #	Tamaño
SL-010-04	13.5 cm (5 ¼")



• OTROS

Weitlaner Separadores

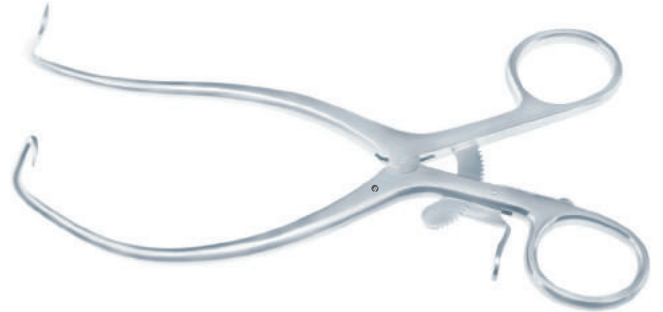

Catálogo #	Tamaño
RT-807-14	14.5 cm (5 3/4")
RT-807-18	18 cm (7")

Farabeuf Separadores
Conjunto de Fig. 1 y Fig. 2

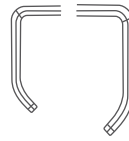

Catálogo #	Tamaño, Tamaño de la hoja Fig. 1, Tamaño de la Hoja Fig. 2
RT-565-00	12 cm (4 3/4"), 26 x 10 mm - 30 x 13 mm, 30 x 10 mm - 34 x 13 mm

Hartmann Pinza Cocodrilo Para Oído



Catálogo #	Tamaño
OT-255-08	8.5 cm (3 1/4")
OT-255-14	14 cm (5 1/2")

Simon Gancho Para Fístulas

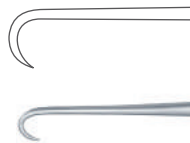

Catálogo #	Tamaño
GY-683-22	21.5 cm (8 1/2")

Stille Cincel

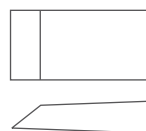

Catálogo #	Tamaño, Tamaño de la hoja
OR-328-10	20 cm (8"), 10 mm



• OTROS

McIndoe Tijeras Para Cartílago
Recta, Con dientes

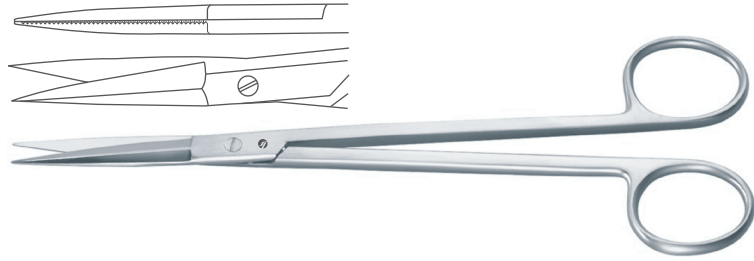

Catálogo #	Tamaño
SS-154-18	18.5 cm (7 1/4")

Hausmann Emasculador



Catálogo #	Tamaño
VT-133-00	Standard

Pinza Paño De Campo Backhaus

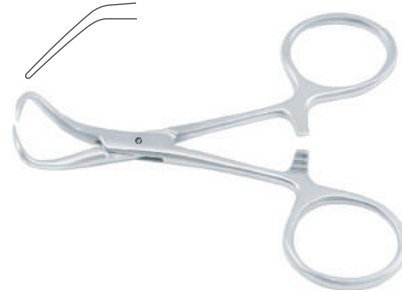

Catálogo #	Tamaño
AF-773-11	11.5 cm (4 1/2")



• SETS SPECIALTY • SET BÁSICO DE CIRUGÍA

Graham Dura Hook Blunt



Catálogo #	Tamaño
NS-237-16	16.5 cm (6 1/2")

Mayo-Hegar Porta Agujas

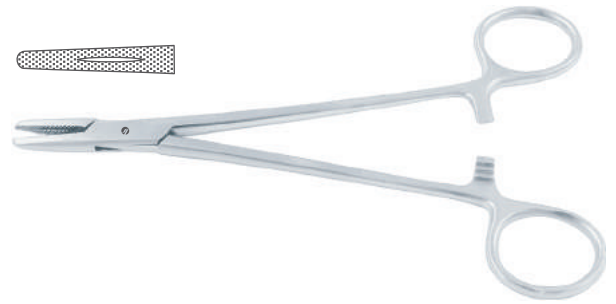

Catálogo #	Tamaño
SU-060-14	14.5 cm (5 3/4")

Mango de Bisturí # 3
Macizo



Catálogo #	Tamaño
SL-010-03	12 cm (4 3/4")

Adson-Brown Pinza De Disección

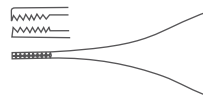

Catálogo #	Tamaño
FR-258-12	12 cm (4 3/4"), 7 x 7 Teeth



Metzerbaum Tijeras de Disección
Recta, Romo/Romo

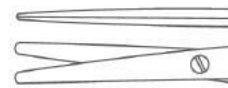

Catálogo #	Tamaño
SS-122-15	15.5 cm (6")



- SETS SPECIALTY
- SET BÁSICO DE CIRUGÍA

Pinza Paño de Campo Backhaus

Catálogo #	Tamaño
AF-773-11	11.5 cm (4 1/2")

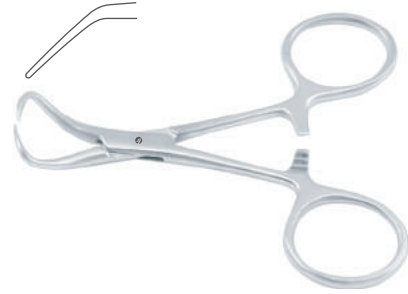

Halsted-Mosquito Pinza Hemostática Recta

Catálogo #	Tamaño
AF-160-12	12.5 cm (4 3/4")

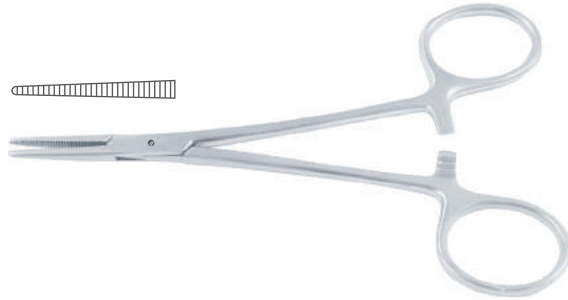

Halsted-Mosquito Pinza Hemostática Curva

Catálogo #	Tamaño
AF-161-12	12 cm (4 3/4")

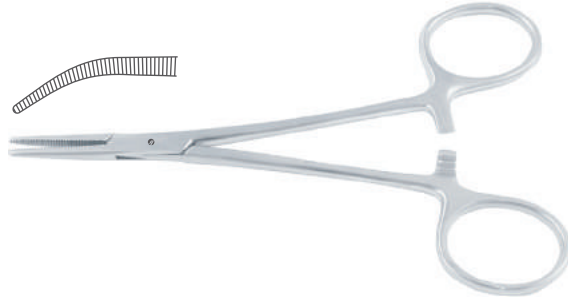

Kelly Pinza Hemostática Recta

Catálogo #	Tamaño
AF-200-14	14.5 cm (5 3/4")

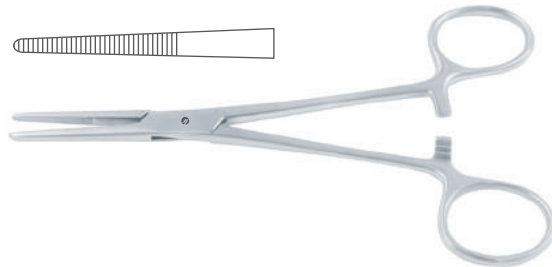

Allis Pinza Para Coger Tejidos E Intestinos 4 x 5 Dientes

Catálogo #	Tamaño
SI-010-12	13 cm (5")

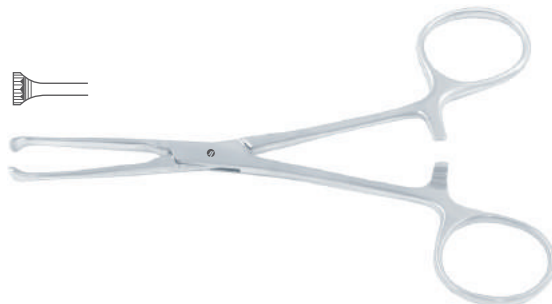



- SETS SPECIALTY
- SET BÁSICO DE CIRUGÍA

Rochester-Pean Pinza Hemostatica
Curva

Catálogo #	Tamaño
AF-221-20	20 cm (8")

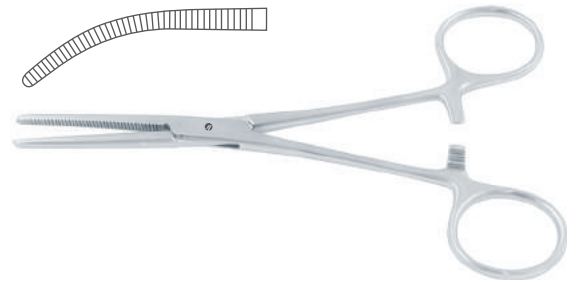



• SET CIRUGÍA OCULAR

Castroviejo Micro Porta Agujas
Recta, Estándar, Con Cierre

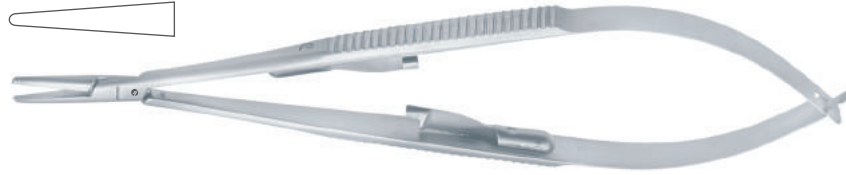

Catálogo #	Tamaño
SU-222-14	14 cm (5 1/2")

Castroviejo Universal Tijeras para Cornea
Curva, Puntas Romas, Cuchillas pequeñas

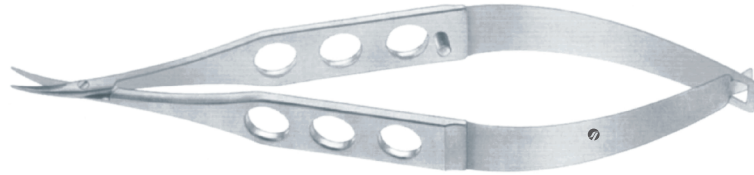

Catálogo #	Tamaño
SS-667-11	11 cm (4 1/2")

Espéculo De Ojo
Alambre Estándar

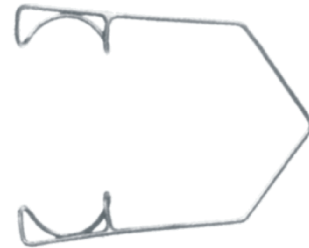

Catálogo #	Tamaño de la Hoja
OP-010-10	10 mm

Desmarres Pinza De Chalazion
Grande, Oval Mandíbulas



Catálogo #	Tamaño, Jaw Tamaño
FR-918-09	9.5 cm (3 3/4"), 20 x 13 mm

Stevens Tijeras para Tenotomia
Curva, Romo/Romo

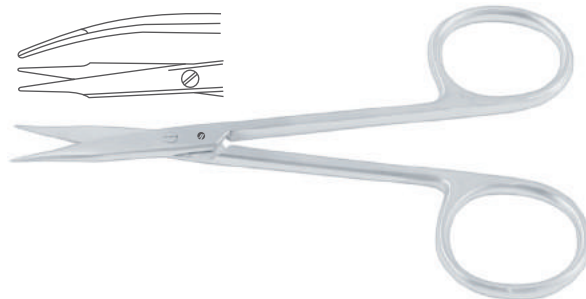

Catálogo #	Tamaño
SS-453-11	11 cm (4 1/2")



• SET CIRUGÍA OCULAR

Bonn Pinza para Cornea
Muy delicado 1 x 2 Dientes



Catálogo #	Tamaño, Tip Tamaño
FR-730-08	8.5 cm (3 1/4"), 0.12 mm



Micro-Mosquito Pinza Hemostatica
Recta



Catálogo #	Tamaño
AF-170-10	10 cm (4")

Micro-Mosquito Pinza Hemostatica
Curva



Catálogo #	Tamaño
AF-171-12	11.5 cm (4 1/2")



• SET ESTERILIZACIÓN GATA

Adson-Brown Pinza De Diseccion

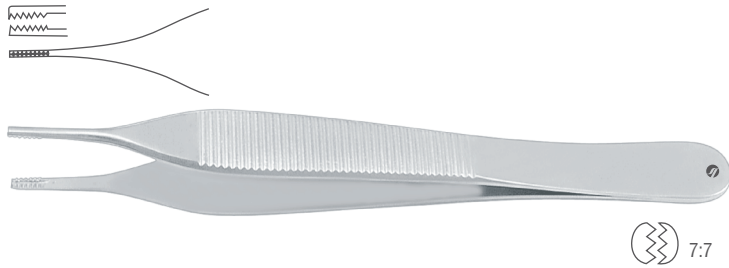

Catálogo #	Tamaño
FR-258-12	12 cm (4 3/4"), 7 x 7 Teeth

Halsted-Mosquito Pinza Hemostatica Curva

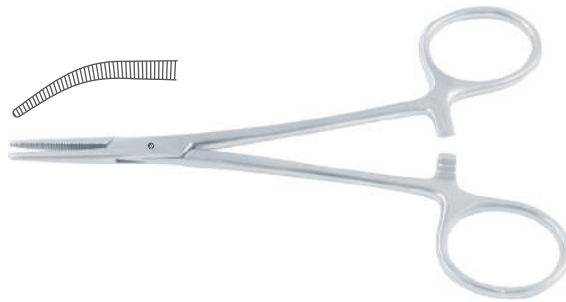

Catálogo #	Tamaño
AF-161-12	12 cm (4 3/4")

Kelly Pinza Hemostatica Curva

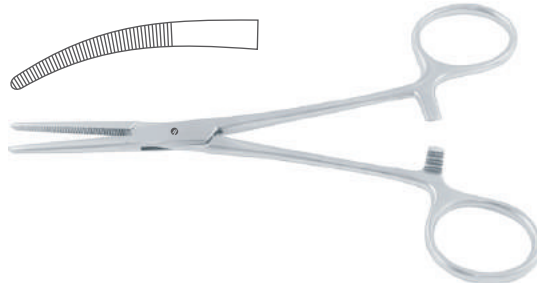

Catálogo #	Tamaño
AF-201-14	14 cm (5 1/2")

Rochester-Carmalt Pinza Hemostatica Recta



Catálogo #	Tamaño
AF-320-16	16.5 cm (6 1/2")

Pinza Paño de Campo Backhaus



Catálogo #	Tamaño
AF-773-11	11.5 cm (4 1/2")



• SET ESTERILIZACIÓN GATA

Mayo-Hegar Porta Agujas



Catálogo #	Tamaño
SU-060-14	14.5 cm (5 3/4")

Allis Pinza Para Coger Tejidos E Intestinos
4 x 5 Dientes

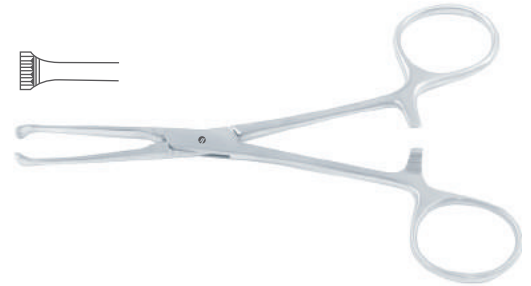

Catálogo #	Tamaño
SI-012-15	15.5 cm (6")

Graham Ganchos
Romo



Catálogo #	Tamaño
NS-237-16	16.5 cm (6 1/2")

Mango de Bisturí # 3
Macizo



Catálogo #	Tamaño
SL-010-03	12 cm (4 3/4")

Halsted-Mosquito Pinza Hemostática
Recta



Catálogo #	Tamaño
AF-160-12	12.5 cm (4 3/4")



• SET ESTERILIZACIÓN GATA

Kelly Pinza Hemostática
Recta

Catálogo #	Tamaño
AF-200-14	14.5 cm (5 ¾")



Adson-Brown Pinza De Diseccion

Catálogo #	Tamaño
FR-258-12	12 cm (4 ¾"), 7 x 7 Teeth

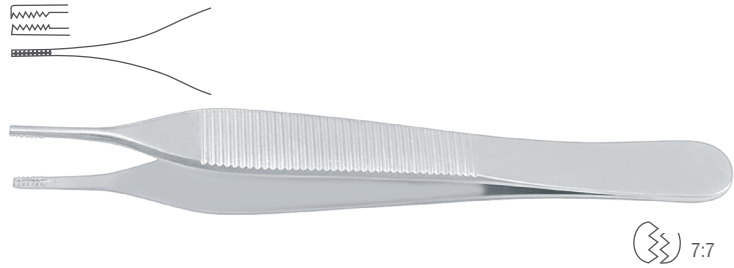

Kelly Pinza Hemostática
Curva

Catálogo #	Tamaño
AF-201-14	14 cm (5 ½")

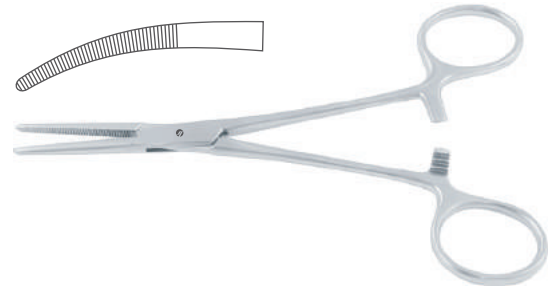



• SET ESTERILIZACIÓN PERRA

Rochester-Carmalt Pinza Hemostatica Recta

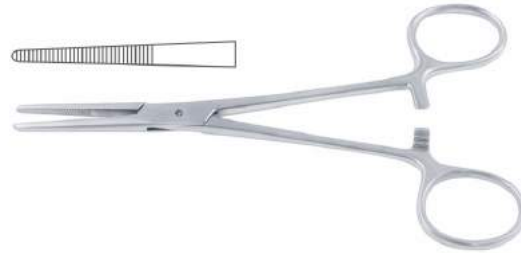

Catálogo #	Tamaño
AF-320-16	16.5 cm (6 1/2")

Pinza Paño de Campo Backhaus

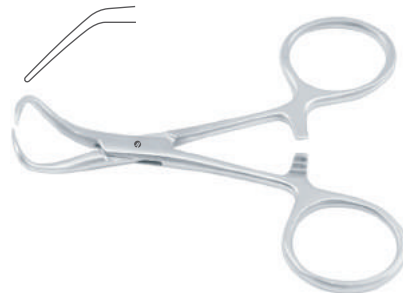

Catálogo #	Tamaño
AF-773-11	11.5 cm (4 1/2")

Mayo-Hegar Porta Agujas



Catálogo #	Tamaño
SU-060-14	14.5 cm (5 3/4")

Allis Pinza Para Coger Tejidos E Intestinos
4 x 5 Dientes

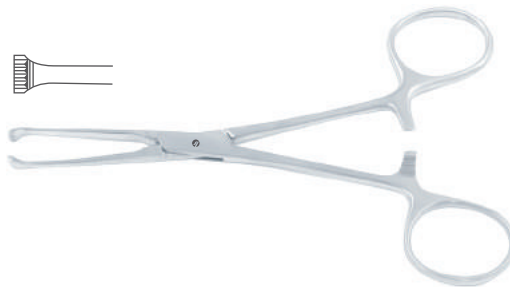

Catálogo #	Tamaño
SI-012-15	15.5 cm (6")

Graham Ganchos
Romo



Catálogo #	Tamaño
NS-237-16	16.5 cm (6 1/2")



• SET ESTERILIZACION PERRA

Mango de Bisturí # 3
Macizo



Catálogo #	Tamaño
SL-010-03	12 cm (4 3/4")

Halsted-Mosquito Pinza Hemostática
Recta



Catálogo #	Tamaño
AF-160-12	12.5 cm (4 3/4")

Kelly Pinza Hemostática
Recta



Catálogo #	Tamaño
AF-200-14	14.5 cm (5 3/4")



• SET DENTAL

Abrebocas Canine
Fig. 250 D

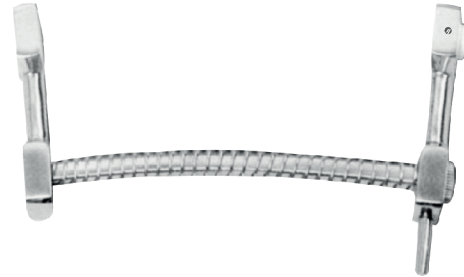

Catálogo #	Tamaño
VT-397-00	Standard

Molt Cucharillas Cotantes



Catálogo #	Tamaño
OR-580-04	17 cm (6 3/4"), Fig. 4

Solt Periodontal Cincel
Fig. 3/4



Catálogo #	Tamaño
DS-363-03	Standard

English Pattern Pinza De Extracción
Fig. 1 (Para centrales superiores, caninos y raíces)



Catálogo #	Tamaño
DS-250-01	Standard

Kramer-Nevins Periodontal Cucharillas Cotantes
Fig. 3/4



Catálogo #	Tamaño
DS-347-34	Standard



• SET DENTAL

Rhodes Trasera Acción Cíncel
Fig. 36/37



Catálogo #	Tamaño
DS-363-01	Standard

Heidbrink Elevador Bra Raices
Fig. 2



Catálogo #	Tamaño
DS-168-02	Standard

Stieglitz Pinzas Para Espinas
Curva

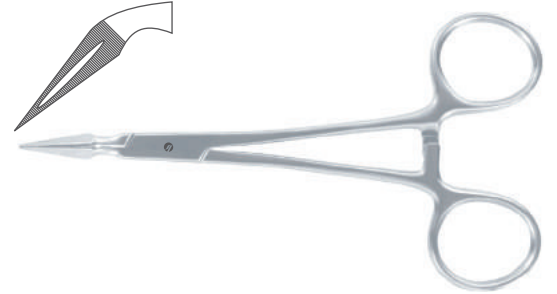

Catálogo #	Tamaño
FR-651-14	13.5 cm (5 1/4")

Locklin Tijeras para Encías
Angulo

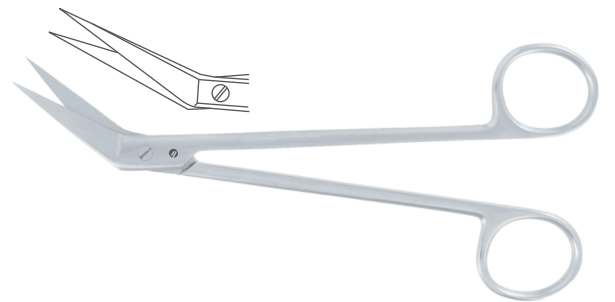

Catálogo #	Tamaño
SS-417-16	16 cm (6 1/4")



COPYRIGHT NOTICE

The copyright, trademarks, domain names and other intellectual property rights in all materials and information in this presentation belongs to Surtex Instruments Ltd. All rights are reserved. Technical alterations are possible. This presentation may be used for no other purpose than offering, buying and selling of Surtex Instruments products. No part may be reproduced or copied in any form. In the event of misuse we retain the right to recall our Catalogues and take appropriate legal action.

DISCLAIMER

This documents provides general information about Surtex Instruments Ltd, its products and services, and summarises general capabilities and offerings, which we deem to be relevant to our customers. Whilst Surtex Instruments has taken appropriate steps to ensure the accuracy of the information contained in the document Surtex Instruments gives no warranty regarding the accuracy or completeness of such information.

The presentation was prepared to provide information and does not constitute a contract. Surtex reserves the right, without prior notice, to change, delete, supplement, or otherwise amend at any time the information, images and offerings contained in the presentation or other documents. Surtex shall not be liable for any loss or damage of whatever nature (whether direct, indirect, consequential or other) may arise as a result of any third party relying on the information contained in this document.

For further detailed information, prices, terms and conditions, customer should contact Surtex Instruments at sales@surtex-instruments.co.uk.



Unit 202 Kingspark Business Centre
152-178 Kingston Road, New Malden
Surrey KT3 3ST United Kingdom
Phone: +44 (0) 208 123 3513

E-mail: sales@surtex-instruments.co.uk
Website: www.surtex-instruments.co.uk



A member of the ABHI



Association of
British Health
Tech
Industries